

ADAME TECH

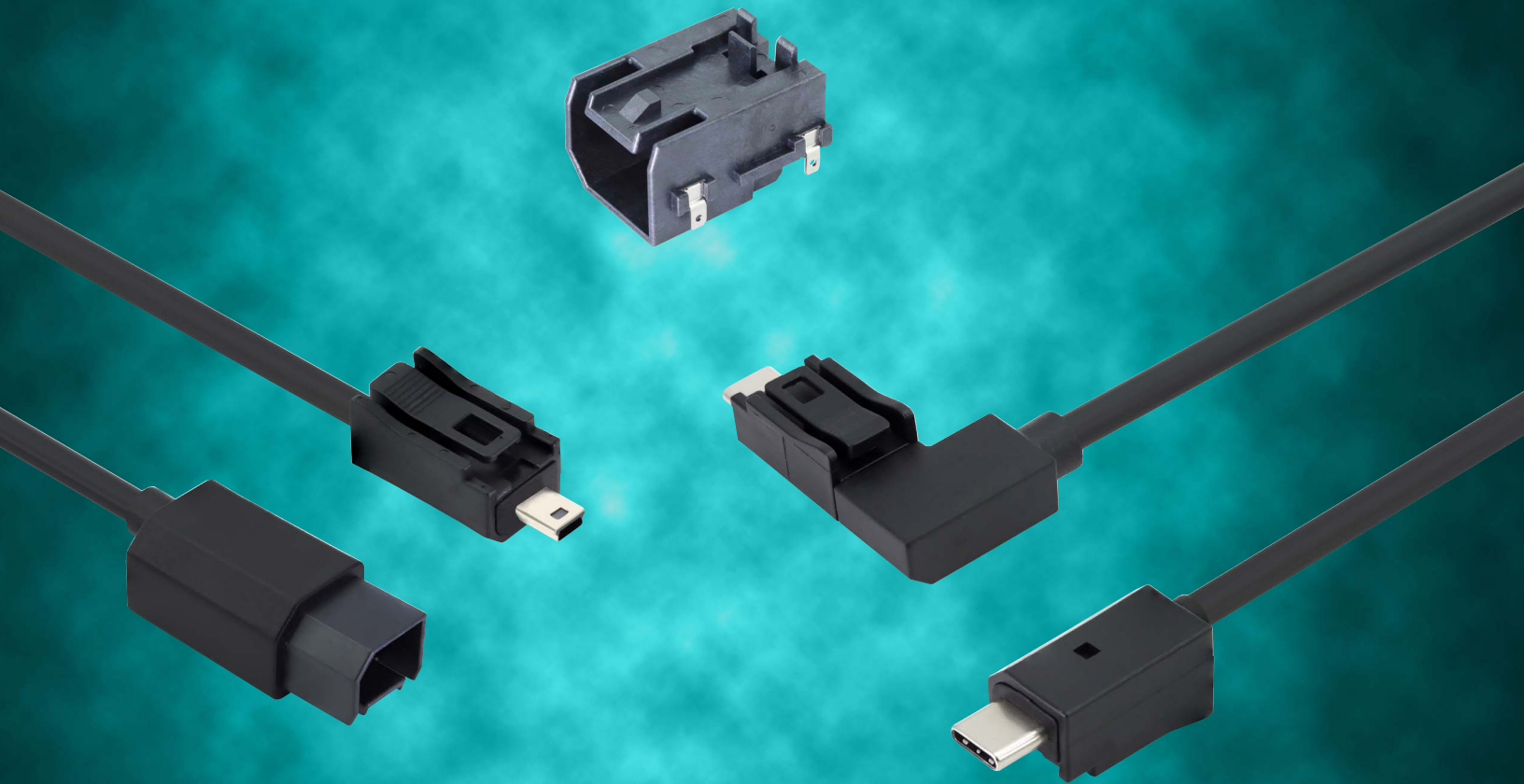

HSecurLinC USB Latching
Connectors and Cables

HSecurLinC USB Latching Connectors and Cables

Adam Tech’s extensive line of USB products is further enhanced by our HSecurLinC USB Latching Connectors and Cables. This series is composed of USB Type-C (including USB4) and Mini USB products, each featuring a secure latch to ensure reliable connections between mated connectors and cables. These products are offered in speeds of 480Mbps, 5Gbps, and 40Gbps. Cable assembly configurations include male-to-male, female-to-female, and female-to-male, with right-angle options available. Additionally, Adam Tech has the capability to manufacture custom cables tailored to meet each customer’s specific needs.

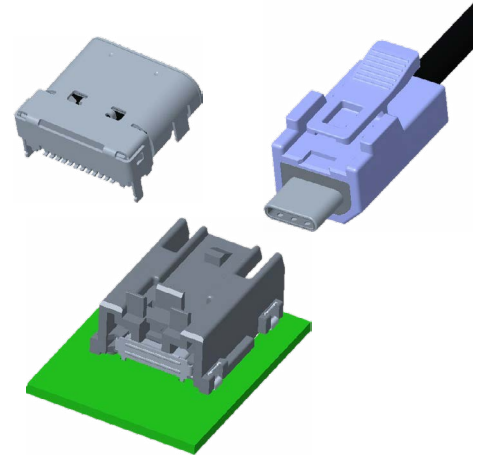

Features and Benefits:

- Latch for secure and reliable mating connections during vibration and motion.
- USB Type-C and Mini USB connectors and cables
- USB4 connector and cables
- Data transmission speeds: 480Mbps, 5Gbps, and 40Gbps
- Backwards compatibility to USB 2.0 and USB 3.1 standards
- Keyed system, with color coded options to prevent mis-mating and compliant to automotive requirements.
- Shrouded and secure over-molded shell to prevent connector damage.
- Cable assembly options: female to female, male to male, and male to female
- Right angle option for USB4 and USB 3.1 Type-C cable assemblies
- Flammability class: UL94 V-0
- Latching design to meet USCAR-2 requirements
- Vibration level: V1
- Cable retention force: 100G downward vertical; 40N for 1 minute
- Voltage ratings: 5V to 48V
- Current ratings: 1A to 5A

Applications:

- Device power charging
- Device data transfer
- Infotainment and rear-entertainment systems
- Multi-media systems
- Consumer electronics
- USB charger and media hubs

Product Types:

- Mini USB Type B Connector
- USB4 Type C Connector
- Mini USB Type B Cable Assemblies
- USB 3.1 Type C Cable Assemblies
- USB4 Type C Cable Assemblies

Product Application & Specifications

MINI USB

BASIC INFORMATION:

- Operating temperature: -40~+85°C
- Flammability Class: UL94V-0

ELECTRICAL CHARACTERISTICS:

- Contact Resistance: 30mΩ max (connector), 2 Ω max (cable)
- Insulation Resistance: 100MΩ min (connector), 5 MΩ min at 100V DC (cable)
- Voltage rating: 5V (connector), 5V (cable)
- Current rating: 1A(connector), 1A (cable)

MECHANICAL CHARACTERISTIC:

- Durability: 20 cycles (latch)
- Cable Retention force: 100g downward vertical at 60CM; 40N for 1 minute
- Mating force: 45N max
- Un-mating force: 75N max

USB4/3.1

BASIC INFORMATION:

- Operating temperature: -40~+85°C
- Flammability Class: UL94V-0

ELECTRICAL CHARACTERISTICS:

- Contact Resistance: 40mΩ max (connector), 2 Ω max (cable)
- Insulation Resistance: 100MΩ min (connector), 10 MΩ min at 300V DC (cable)
- Voltage rating: 48V (connector), 20V (cable)
- Current rating: 5A for VBUS Pin and 1.25A for VCONN Pin (connector), 3A or 5A (cable)

MECHANICAL CHARACTERISTIC:

- Durability: 20 cycles (latch)
- Cable Retention force: 100g downward vertical at 60CM; 40N for 1 minute
- Mating force: 45N max
- Un-mating force: 75N max

MUSB-B5-S-RA-AB-A

Mini USB Type B Connector
DIP Type w/ Bridge
480Mbps



[View Datasheet](#)

USB-C40-S-RA-CS5A-X-EH-BK

USB4 Type C Connector
Edge Hang w/ Bridge
40Gbps



[View Datasheet](#)

CA-USB-MBMF-MBMF-XM

Mini USB Type B Cable Assembly
Female to Female
480Mbps



[View Datasheet](#)

CA-USB-MBML-MBFL-XM

Mini USB Type B Cable Assembly
Male to Female
480Mbps



[View Datasheet](#)

CA-USB-MBML-MBML-XM

Mini USB Type B Cable Assembly
Male to Male
480Mbps



[View Datasheet](#)

CA-USB31-CFLX-CFLX-XM

USB 3.1 Type C Cable Assembly
Female to Female
5Gbps



[View Datasheet](#)

CA-USB31-CMLX-CFLX-XM

USB 3.1 Type C Cable Assembly
Male to Female
5Gbps



[View Datasheet](#)

CA-USB31-CMLX-CMLX-XM

USB 3.1 Type C Cable Assembly
Male to Male
5Gbps



[View Datasheet](#)

CA-USB31-CMRLX-CFLX-XM

USB 3.1 Type C Cable Assembly
Male (Right Angle) to Female
5Gbps



[View Datasheet](#)

CA-USB31-CMRLX-CMLX-XM

USB 3.1 Type C Cable Assembly
Male (Right Angle) to Male
5Gbps



[View Datasheet](#)

CA-USB4-CFLX-CFLX-XM

USB4 Type C Cable Assembly
Female to Female
40Gbps



[View Datasheet](#)

CA-USB4-CMLX-CFLX-XM

USB4 Type C Cable Assembly
Male to Female
40Gbps



[View Datasheet](#)

CA-USB4-CMLX-CMLX-XM

USB4 Type C Cable Assembly
Male to Male
40Gbps



[View Datasheet](#)

CA-USB4-CMRLX-CFLX-XM

USB4 Type C Cable Assembly
Male (Right Angle) to Female
40Gbps



[View Datasheet](#)

CA-USB4-CMRLX-CMLX-XM

USB4 Type C Cable Assembly
Male (Right Angle) to Male
40Gbps



[View Datasheet](#)

Highlights

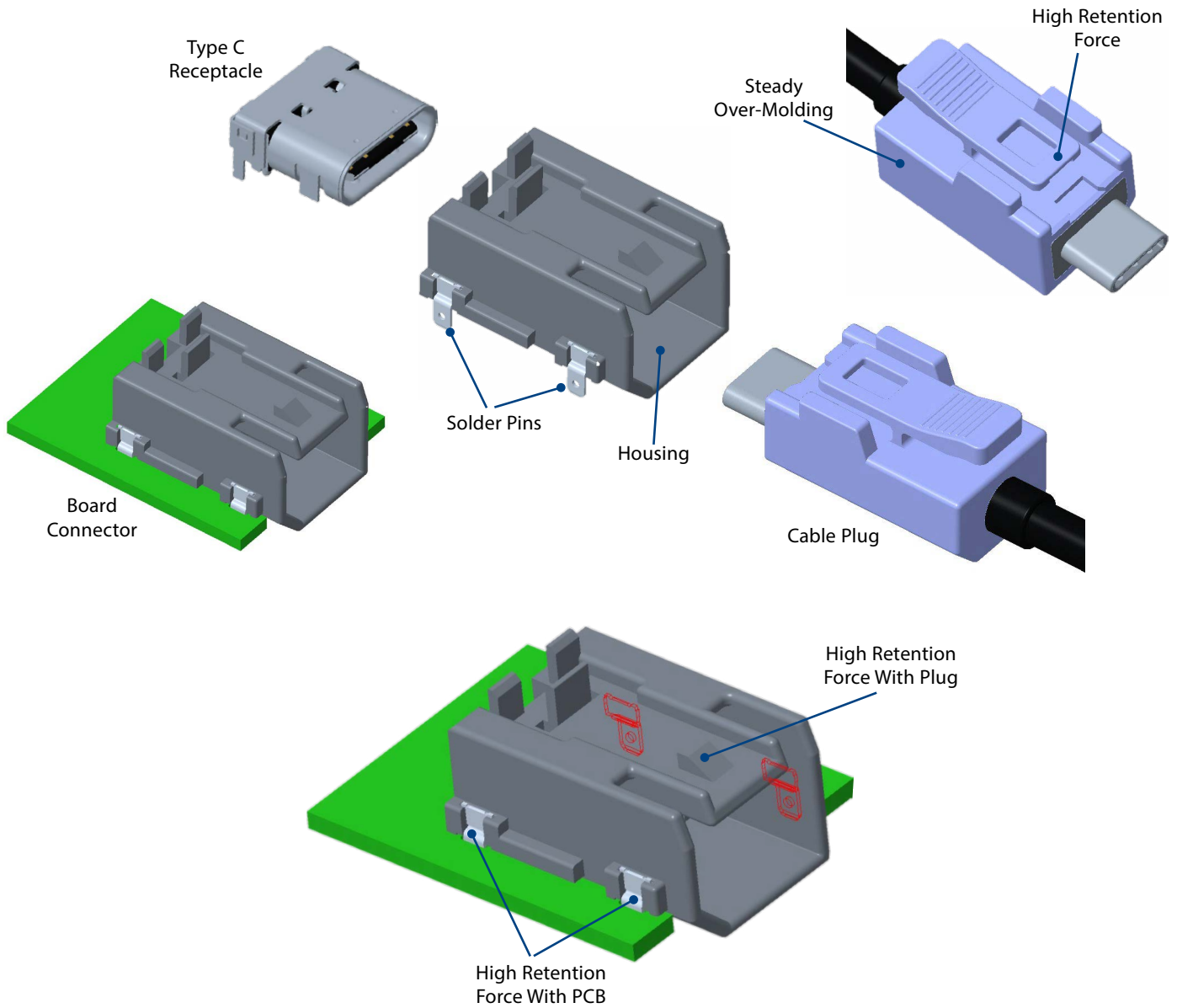

Color Options

Some color specifications are displayed, and the colors are indicative colors. The specific standard colors shall prevail.

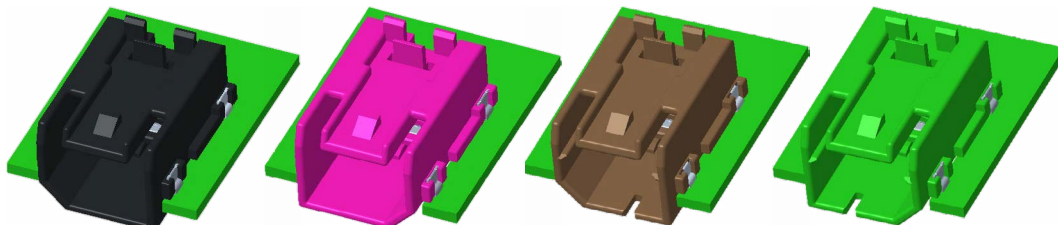

Mini USB Markings and Dimensions

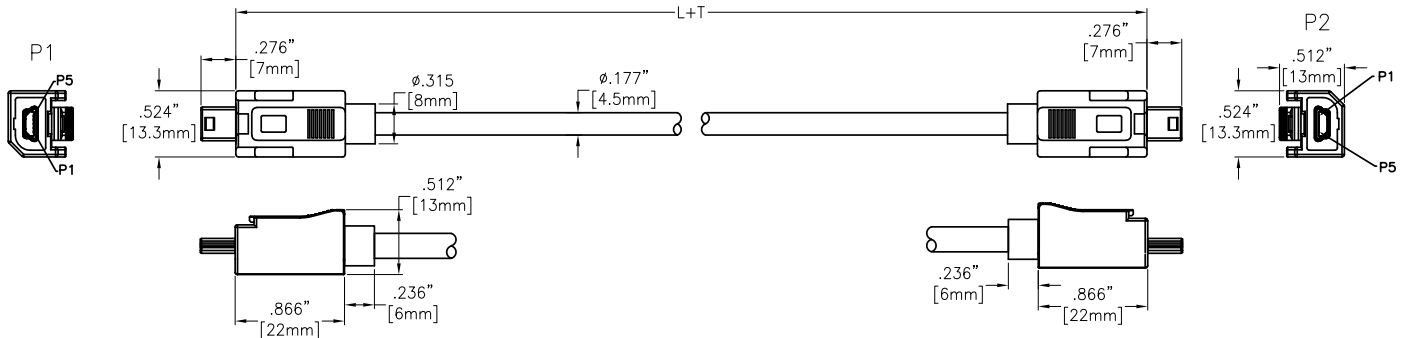
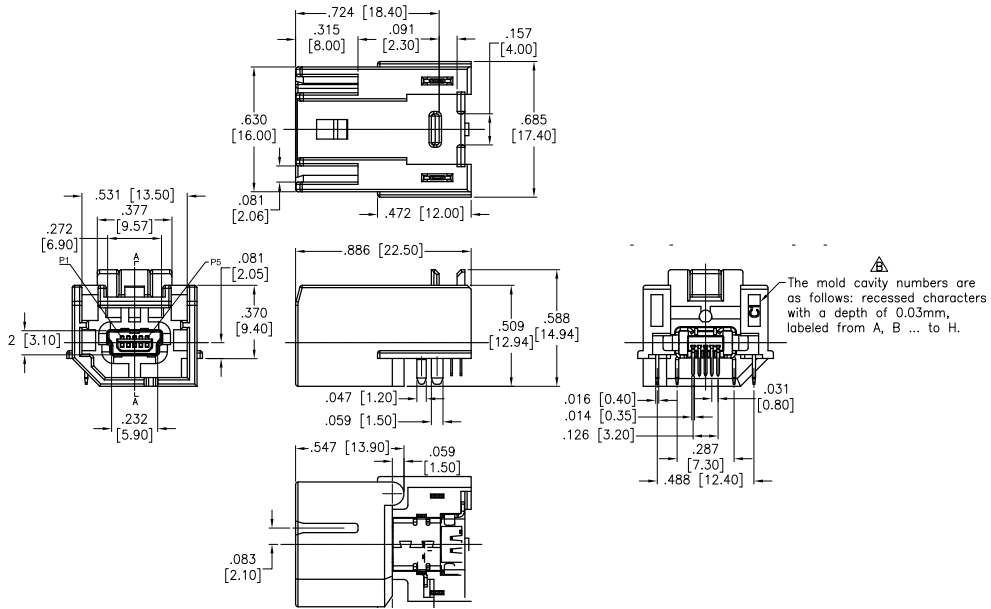

USB4/3.1 Markings and Dimensions

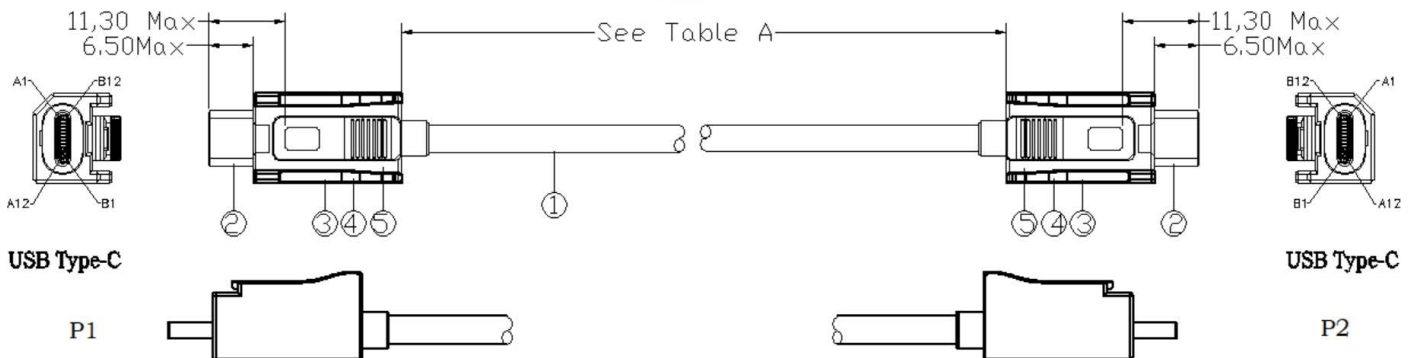
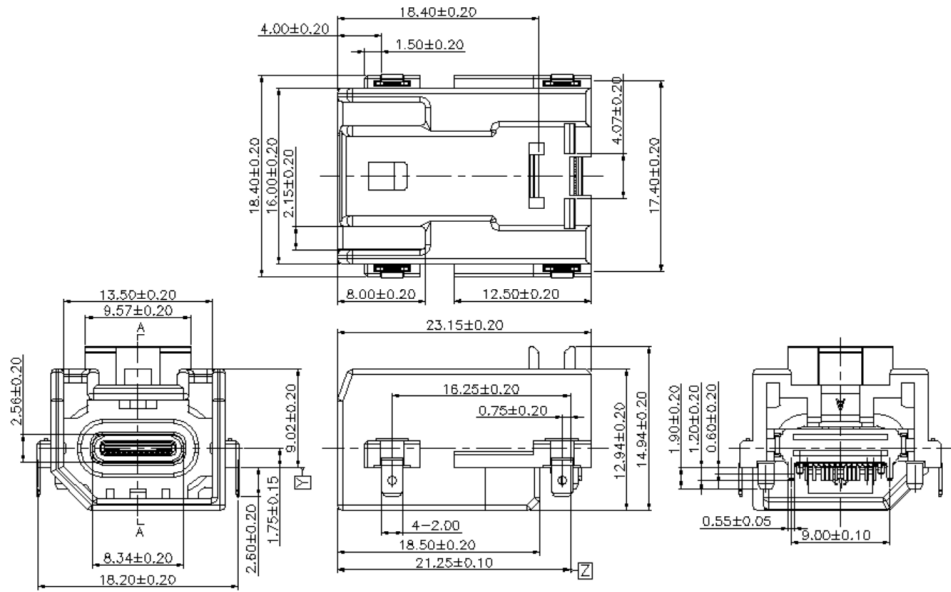
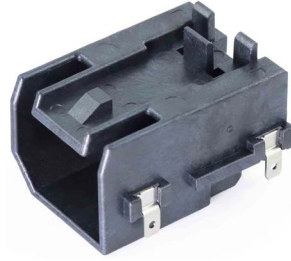

Pin Definition

MINI USB

Pin	Signal Name
1	V bus
2	D-
3	D+
4	ID
5	GND
Shell	SHIELD

USB4/3.1

Pin	Signal Name	Mating Sequence
A1	GND	First
A2	SSTXp1	Second
A3	SSTXn1	Second
A4	V bus	First
A5	CC1	Second
A6	Dp1	Second
A7	Dn1	Second
A8	SBU1	Second
A9	V bus	First
A10	SSRXn2	Second
A11	SSRXp2	Second
A12	GND	First
Shell	GND	

Pin	Signal Name	Mating Sequence
B1	GND	First
B2	SSRXp1	Second
B3	SSRXn1	Second
B4	V bus	First
B5	SBU2	Second
B6	Dn2	Second
B7	Dp2	Second
B8	CC2	Second
B9	V bus	First
B10	SSTXn2	Second
B11	SSTXp2	Second
B12	GND	First
Shell	GND	

Coding Options

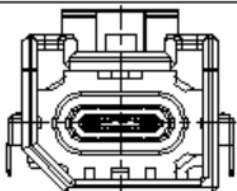
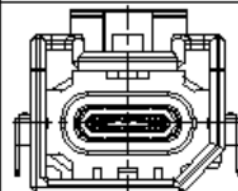
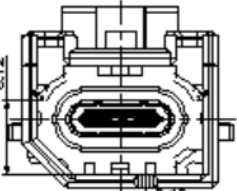
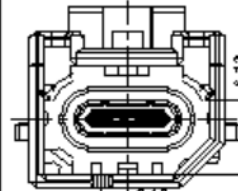
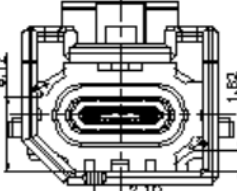
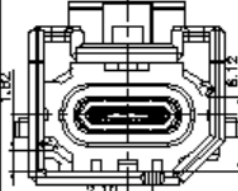
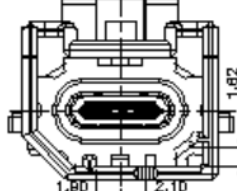
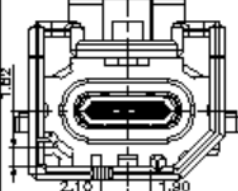
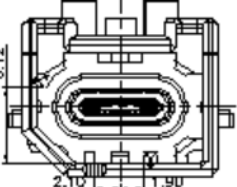
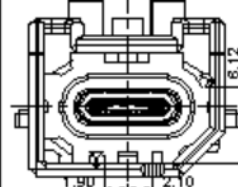
CODE	RECEPTACLE	CASE COLOR	CODE	RECEPTACLE	CASE COLOR
A		JET BLACK	B		CLARET VIOLET
C		NUT BROWN	D		LEAF GREEN
E		SIGNAL BLUE	F		CREAM WHITE
G		BLUE GRAY	H		YELLOW GREEN
J		BEIGE	K		CURRY



To contact us, scan the QR
code to reach our website
inquiry form.



adam-tech.com

Created: Feb-2025