

Features

Power Module

- Buck regulator power module with integrated shielded inductor
- 36VDC input voltage, 4A output current
- Programmable output voltage: 1 to 7V
- Ultra-high power density: 5.0 x 5.5mm QFN footprint
- Enable, power good, soft start
- Flip-chip technology for improved thermal behavior
- UVLO, SCP, OCP, OTP



RPX-4.0

4.0 Amp QFN Package



Description

The RPX-4.0 is a buck converter with an integrated inductor in a compact 5mm x 5.5mm x 4.1mm thermally-enhanced QFN package. The input range is from 3.8 to 36VDC, allowing 5V, 12V, or 24V supply voltages to be used. The output voltage can be set with two resistors in the range from 1 up to 7VDC. The output current is up to 4A and is fully protected against continuous short-circuits, output overcurrent, or over-temperature faults, making the device particularly suitable for industrial automation, test and measurement, portable devices, and high density or weight-sensitive applications.

Selection Guide

Part Number	Input Voltage Range [VDC]	Output Voltage [VDC]	Output Current max. [mA]	Efficiency ⁽¹⁾ typ. [%]
RPX-4.0	3.8 - 36	1 - 7	0 - 4000	87

Notes:

Note1: Efficiency tested at +V_{IN}= 24VDC, full load and V_{OUT}= 5VDC

Model Numbering

RPX-4.0-

Output Current ——— Packaging ⁽²⁾

Notes:

Note2: add suffix "-R" for tape and reel packaging
add suffix "-CT" for bag packaging (refer to "PACKAGING INFORMATION")

Specifications

ABSOLUTE MAX RATINGS (exceeding these ratings may damage the device)

Parameter	Conditions	Min.	Typ.	Max.
Absolute Maximum Voltage	+V _{IN} to -V _{IN}	-0.3VDC		38VDC
	CTRL to GND	-0.3VDC		38.3VDC
	FB to GND	-0.3VDC		5.5VDC
	PG to GND	-0.1VDC		18VDC
	GND to -V _{IN}	-0.3VDC		0.3VDC
	V _{OUT} to -V _{IN}	-0.3VDC		7VDC
	PGS to -V _{IN}	-0.3VDC		5.5VDC

continued on next page



www.recom-power.com/eval-ref-boards

Specifications

Parameter	Conditions	Min.	Typ.	Max.
Junction Temperature ⁽³⁾		-40°C		+125°C
Lead Temperature				+240°C
Storage Temperature		-55°C		+150°C
Maximum number of reflows				3
Mechanical Shock	MIL-STD-883D, Method 2002.3, 1msec, 1/2 sine, mounted			500G
Mechanical Vibration	MIL-STD-883D, Method 2007.2, 20 to 2000 Hz			20G

Notes:

Note3: The ambient temperature is the air temperature of the surrounding environment. The junction temperature is the temperature of the internal power IC when the device is powered. Operating below the maximum ambient temperature, as shown in the **“Safe Operating Area”** ensures that the maximum junction temperature of any component inside the module is never exceeded.

OPERATING CONDITIONS (+V_{IN} = 12VDC, T_{AMB} = +25°C, unless otherwise noted)

Parameter	Condition	Min.	Typ.	Max.
Input Voltage Range ⁽⁴⁾		3.8VDC		36VDC
Under Voltage Lockout	DC-DC ON, V _{OUT} = 2.5VDC, I _{OUT} = 0A DC-DC OFF, V _{OUT} = 2.5VDC, I _{OUT} = 0A		3.12VDC 2.62VDC	
Input Capacitance		2x 10µF X5R or X7R		
Output Capacitance	refer to “OUTPUT VOLTAGE SETTING”	26µF		1000µF
Output Voltage Range	refer to “Safe Operating Area”	1VDC		7VDC
Output Current Range	@natural convection, T _{AMB} = 25°C	0A		4A
Standby Current	DC-DC OFF		5µA	10µA
Feedback Voltage ⁽⁵⁾	@ no load, from V _{OUT} + V _{DROP} to max +V _{IN}	0.985VDC	1.0VDC	1.015VDC
Load Regulation	0-100% load, T _{AMB} = +25°C		±0.40%	
Line Regulation			0.15%	
Internal Soft Start Time			5ms	
Output Ripple and Noise ⁽⁶⁾	20Mhz BW		30mVp-p	

Notes:

Note4: The recommended minimum +V_{IN} is 3.8VDC or (V_{OUT} + 1VDC), whichever is greater. Refer to **“Safe Operating Area”**

Note5: The overall output voltage tolerance will be affected by the tolerance of the external R_{FB1} and R_{FB2} resistors.

Typical Application

Below is a design example following the application guidelines for the specifications below.
Design parameter: +V_{IN} = 24VDC, V_{OUT} = 5VDC, I_{OUT} = 4A

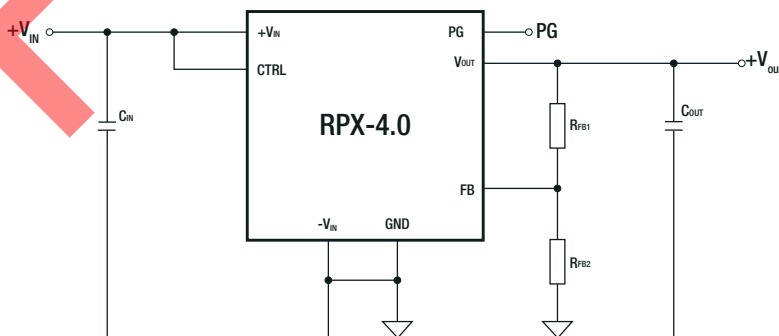

Recommended Values			
C _{IN} [µF]	R _{FB1} [Ω]	R _{FB2} [Ω]	C _{OUT} [µF]
2x 10µF	10k	2k49	2x 47µF

continued on next page

Specifications

Safe Operating Area

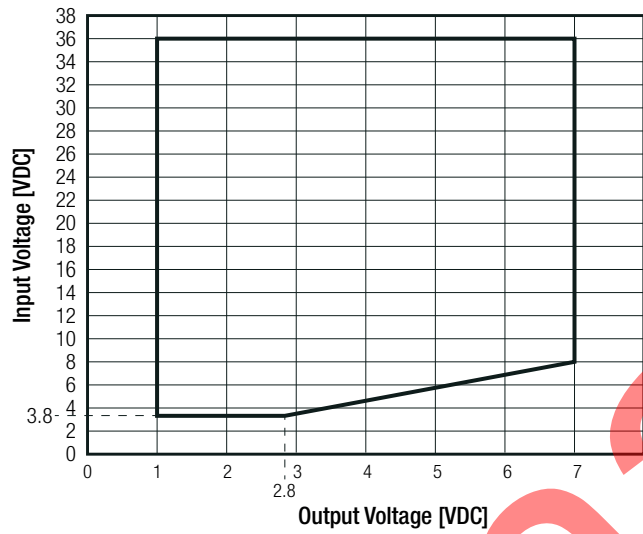

CTRL OPERATING CONDITIONS

Parameter	Condition	Min.	Typ.	Max.
CTRL Voltage Range	V_{CTRL}	0VDC		36VDC
CTRL ON/OFF	ON	>1.20VDC	1.23VDC	1.26VDC
	STANDBY		$0.3VDC \leq V_{CTRL} \leq 1VDC$	
	OFF			<0.3VDC
CTRL Hysteresis Voltage	$V_{CTRL-HYS}$		100mV	
CTRL Input Current ⁽⁶⁾	$+V_{IN} = 12VDC, V_{FB} = 1.5VDC, V_{CTRL} = 2VDC$		1.4nA	200nA

Notes:

Note6: CTRL is a digital control pin that turns the module on and off.
Drive CTRL high to turn on the module; drive CTRL low to turn it off

Enabling the device

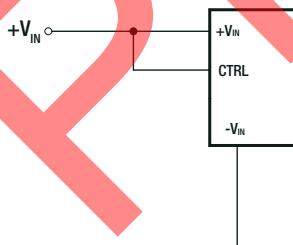

Typical enable control

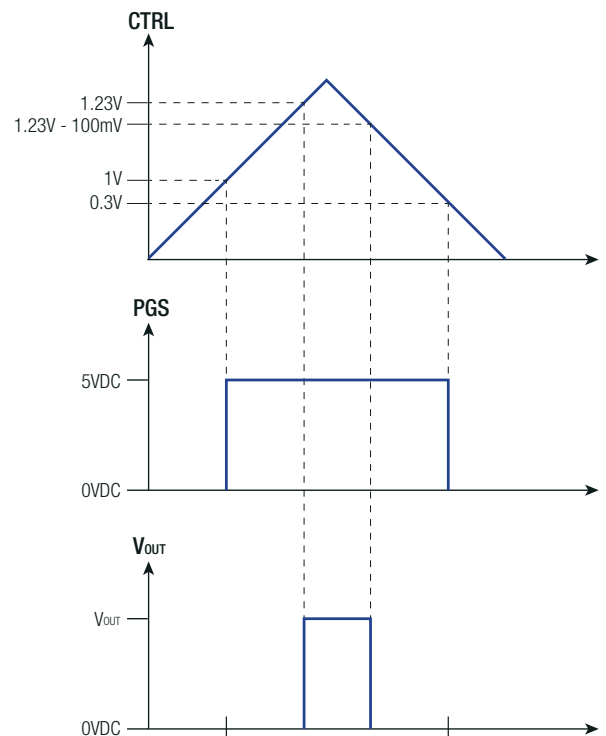
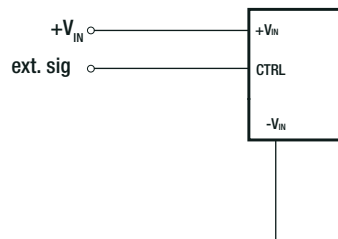

Specifications

OUTPUT VOLTAGE SETTING

A resistor divider connected to the FB pin (pin 9) sets the output voltage of the RPX-4.0. The output voltage adjustment range is from 1VDC to 7VDC. The graph below shows the feedback resistor connections for setting the output voltage. The recommended value of R_{FB1} is 10k Ω . Use the equation to calculate the value for R_{FB2} . The table below lists the standard resistor values for several output voltages. The capacitance values listed represent the effective capacitance, taking into account the effects of DC V_{OC_ext} and temperature variation.

- V_{out_set} = trimmed output voltage [VDC]
- R_{FB1} = resistor (10k) [Ω]
- R_{FB2} = calculated resistor [Ω]

Calculation:

$$R_{FB2} = \frac{10}{(V_{OUT} - 1)} k\Omega$$

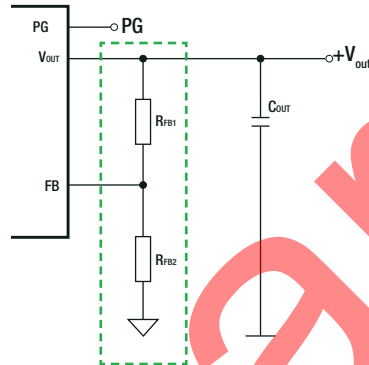

Component Values		
V_{OUTset} [VDC]	R_{FB2} [Ω]	C_{OUT} [μ F]
1.0	open	150
1.1	100k	143
1.2	49k9	132
1.3	33k2	123
1.4	24k9	115
1.5	20k	107
1.8	12k4	91
2.0	10k	82
2.5	6k65	67

Component Values		
V_{OUTset} [VDC]	R_{FB2} [Ω]	C_{OUT} [μ F]
3.0	4k99	57
3.3	4k32	52
4.0	3k32	43
4.5	2k87	39
5.0	2k49	35
5.5	2k21	32
6.0	2k	30
6.5	1k82	28
7.0	1k65	26

POWER GOOD OPERATING CONDITIONS

Parameter	Condition	Min.	Typ.	Max.
PG Pull Up Voltage		OVDC		7VDC
PG Thresholds	Overvoltage Undervoltage		107% 92%	
PG Low Voltage	0.5mA pull-up $V_{CTRL} = OVDC$		0.2VDC	
Minimum $+V_{IN}$ for valid PG	50 μ A pull-up $V_{CTRL} = OVDC, T_J = T_A = +25^\circ C$		2VDC	

The RPX-4.0 has a built-in power-good signal (PG) which indicates whether the output voltage is within its regulation range. The PG pin is an open-drain output that requires a pull-up resistor to a nominal voltage source of 18VDC or less. The internal 5-V LDO output (PGS pin), can be used as the pull-up voltage source. A typical pull-up resistor value is between 10k Ω and 100k Ω . The maximum recommended PG sink current is 3mA. Once the output voltage rises above 94% of the set voltage, the PG pin rises to the pull-up voltage level. The PG pin is pulled low when the output voltage drops lower than 92% or rises higher than 107% of the nominal set voltage.

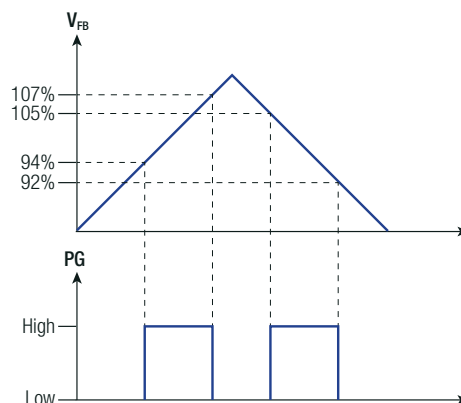

Specifications

SWITCHING CHARACTERISTICS

Parameter	Condition	Min.	Typ.	Max.
Switching Frequency Range	$I_{OUT} = 2A$		1400kHz	

PROTECTIONS

Parameter	Condition	Min.	Typ.	Max.
Over Current Protection (OCP) ⁽⁷⁾	hiccup mode, automatic restart			5.5A
Thermal Shutdown	restart after cooling down	+148°C	+160°C	+165°C

Notes:

Note7: In hiccup mode the RPX-4.0 is shut down and kept off for 10ms typ.

Over Current Protection (OCP)

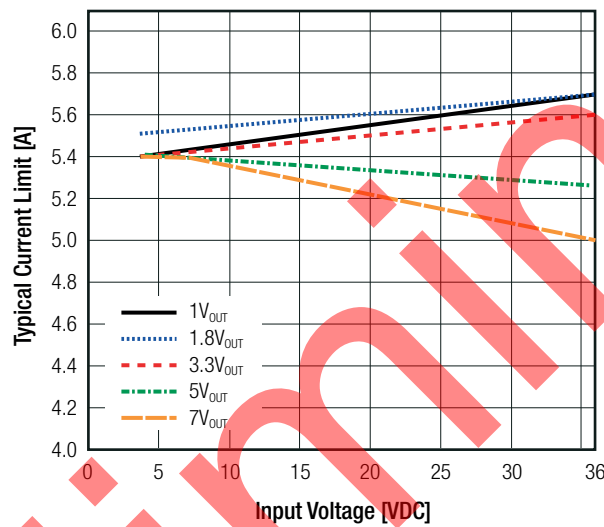

TYPICAL PERFORMANCE CHARACTERISTICS ($V_{OUT} = 1.8VDC$, $T_{AMB} = +25^{\circ}C$; unless otherwise noted)

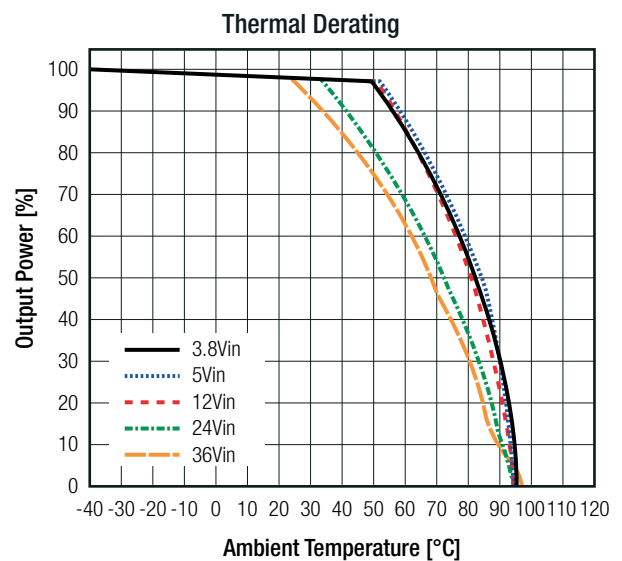
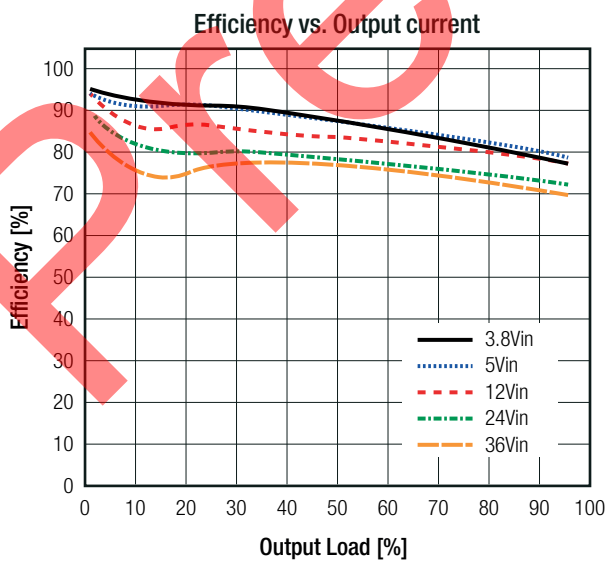

continued on next page

Specifications

TYPICAL PERFORMANCE CHARACTERISTICS ($V_{OUT}= 1.8VDC$, $T_{AMB}= +25^{\circ}C$; unless otherwise noted)

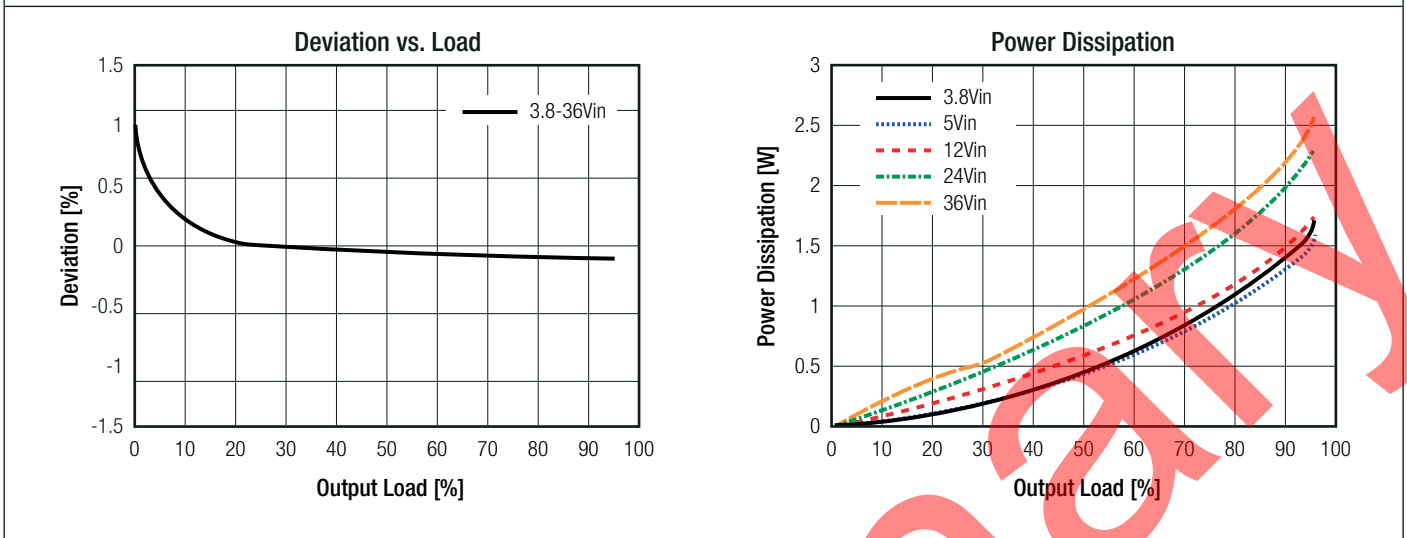

TYPICAL PERFORMANCE CHARACTERISTICS ($V_{OUT}= 3.3VDC$, $T_{AMB}= +25^{\circ}C$; unless otherwise noted)

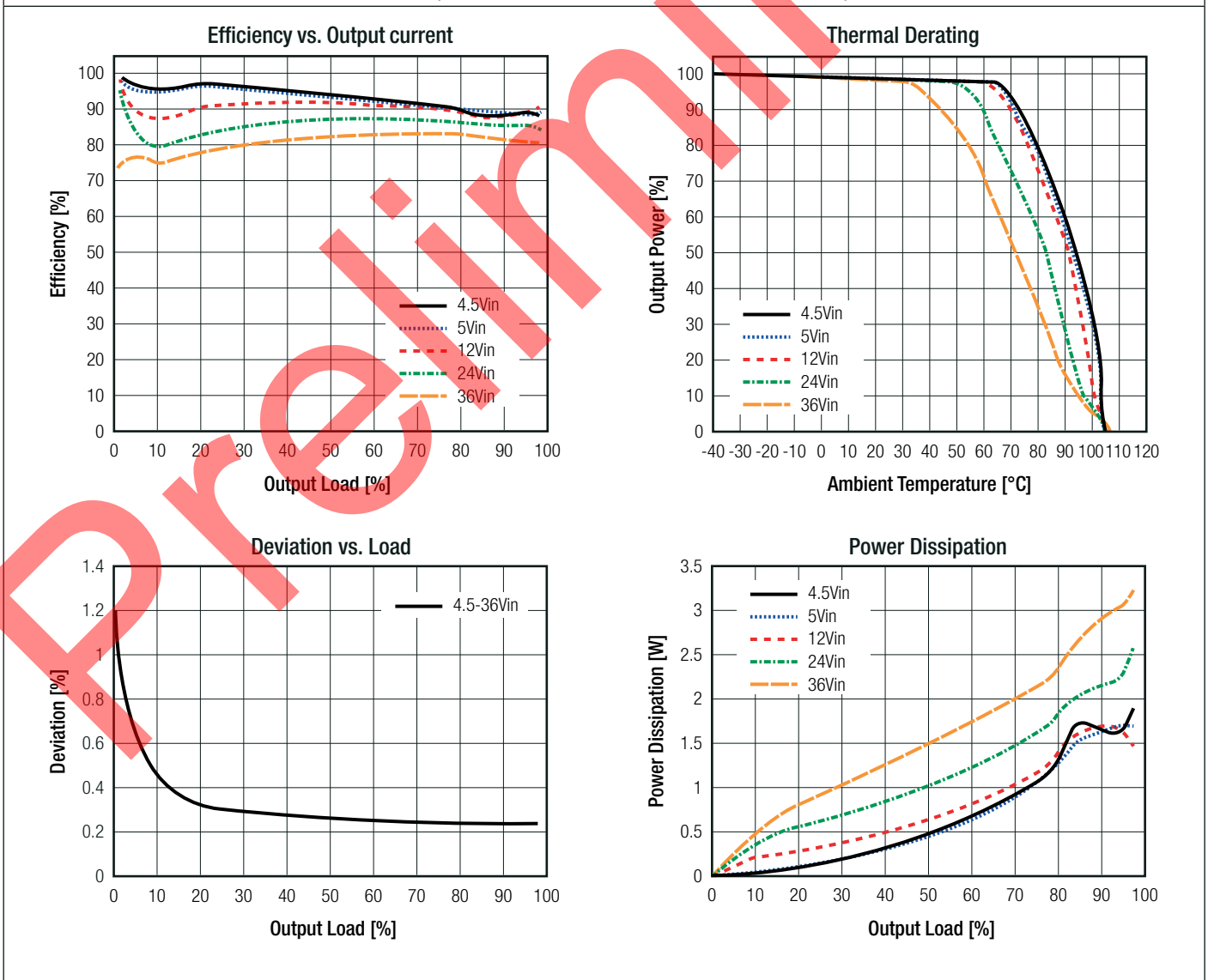

Specifications

TYPICAL PERFORMANCE CHARACTERISTICS ($V_{OUT}= 5VDC$, $T_{AMB}= +25^{\circ}C$; unless otherwise noted)

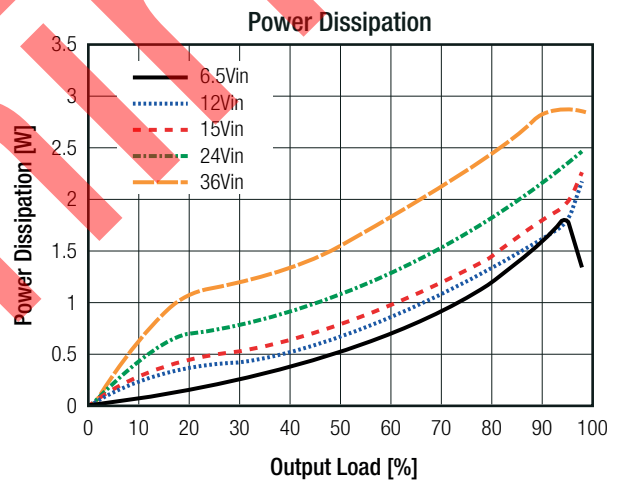
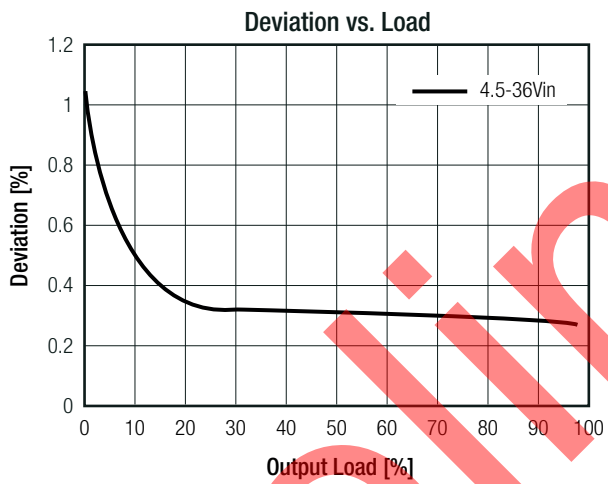
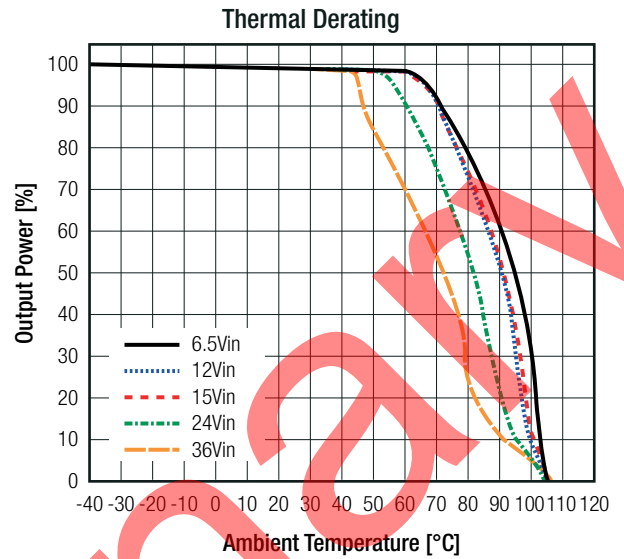
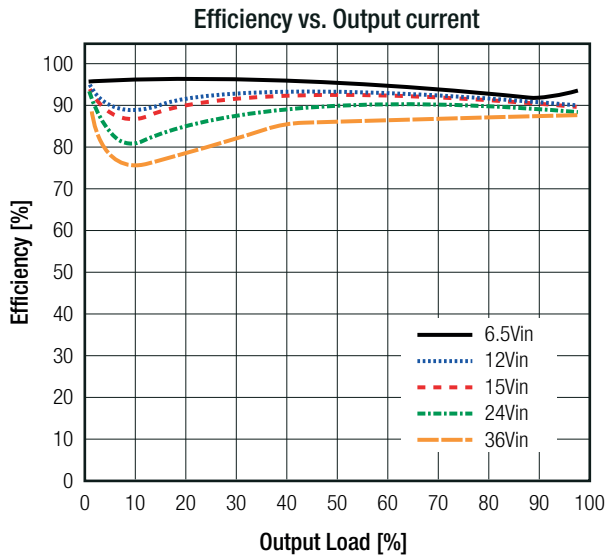

TYPICAL PERFORMANCE CHARACTERISTICS ($V_{OUT}= 7VDC$, $T_{AMB}= +25^{\circ}C$; unless otherwise noted)

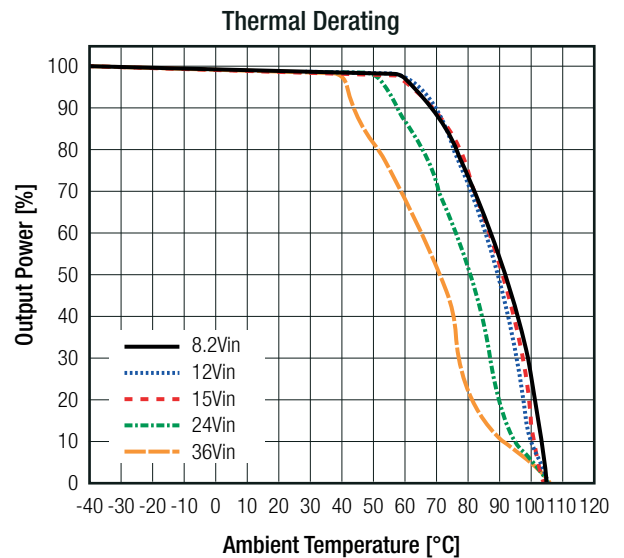
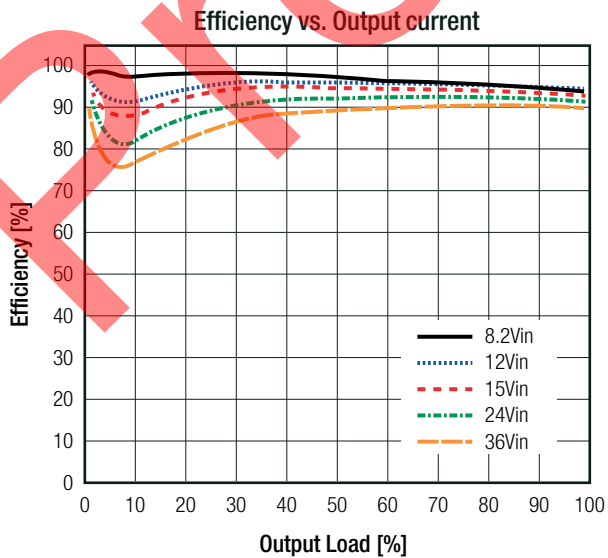

continued on next page

Specifications

TYPICAL PERFORMANCE CHARACTERISTICS ($V_{OUT}=7VDC$, $T_{AMB}=+25^{\circ}C$; unless otherwise noted)

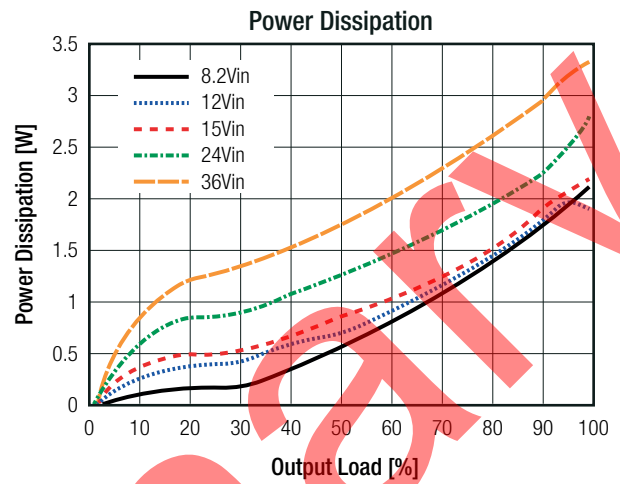
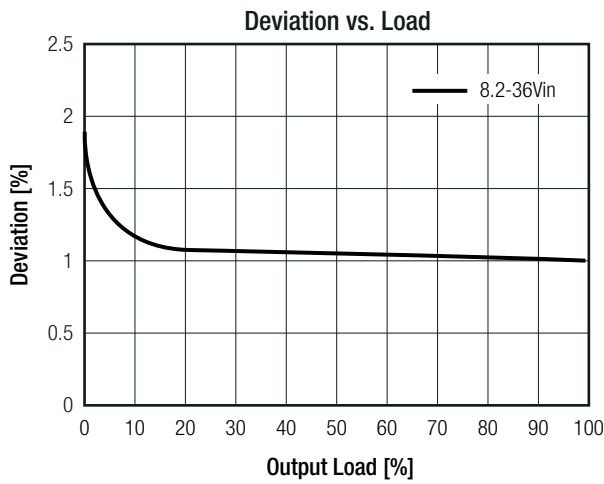

THERMAL OPERATING CONDITIONS ($+V_{IN}=12VDC$, $T_{AMB}=+25^{\circ}C$, unless otherwise noted)

Parameter	Condition	Min.	Typ.	Max.
Operating Ambient Temperature		-40°C		+105°C
Thermal Impedance ⁽⁸⁾	junction to T_{AMB} case to T_{AMB}		19.5K/W 18K/W	
Thermal shutdown	hysteresis		25K	
ESD	Human-body model (HBM), per ANSI/ESDA/JEDEC JS-001 Charged-device model (CDM), per JEDEC specification JESD22-C101			±2.5kVDC ±1.0kVDC
Moisture Sensitive Level	MSL peak temp. ⁽⁹⁾			Level 3, 245°C, 168hrs
MTBF				89.3 x 10 ³ hours

Notes:

Note8: Test PCB= 75 x 75 mm double-sided PCB with 2 oz copper and natural convection.

Note9: The Moisture Sensitivity Level rating according to the JEDEC industry classifications and peak solder temperature

DIMENSION AND PHYSICAL CHARACTERISTICS

Parameter	Type	Value
Material		plastic
Dimension (LxWxH)		5.0 x 5.5 x 4.1mm
Weight		2.0g typ.

continued on next page

Specifications

Dimension Drawing (mm)

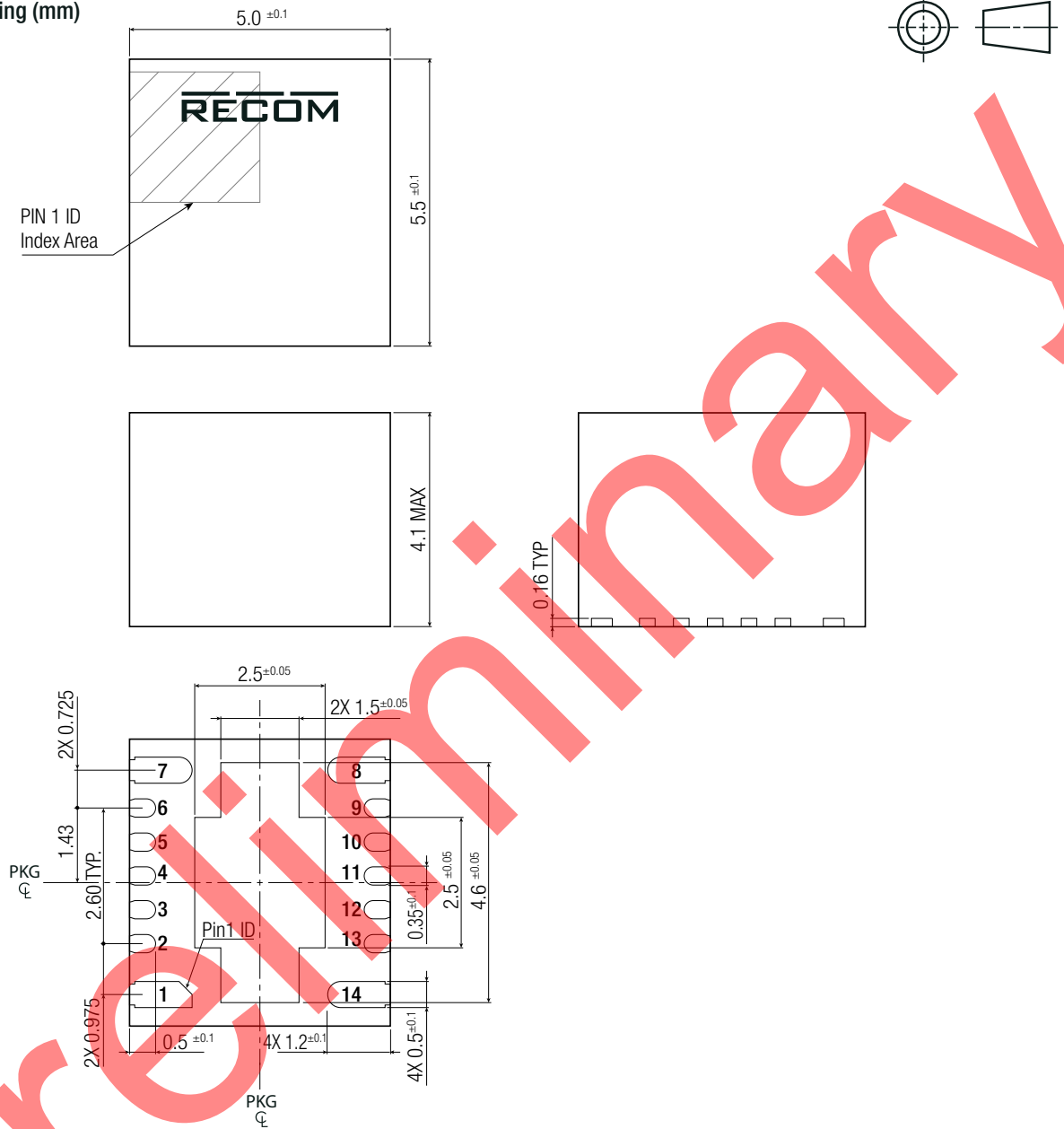

Pad Information

Pad #	Function	Description
12	GND	Analog ground. This pin must be connected to $-V_{IN}$ at a single point. See the layout section.
4, 5	DNC	Do not connect. Must be soldered to an isolated pad.
2	CTRL	CTRL pin. Do not float. Connected directly to $+V_{IN}$ when not used.
9	FB	Feedback input. Used to set output voltage between 1 and 7V.
3, 10, 11	NC	Not connected. Connect to $-V_{IN}$ plane for enhanced EMC and thermal performance.
15	$-V_{IN}$	System ground. Reference ground of the regulated output voltage. Connect to input supply return, load return, and input and output capacitors.
6	PG	Power good output
1, 14	$+V_{IN}$	Input supply voltage. Connect using wide PCB traces. Requires C_{IN} between these pins and $-V_{IN}$ close to the pins.
7, 8	V_{OUT}	Output voltage. Connect external output capacitors between this pin and $-V_{IN}$ close to the pins
13	PGS	Power Good Source. Should only be used as logic supply for PG pin.

Specifications

Recommended Footprint (Top View)

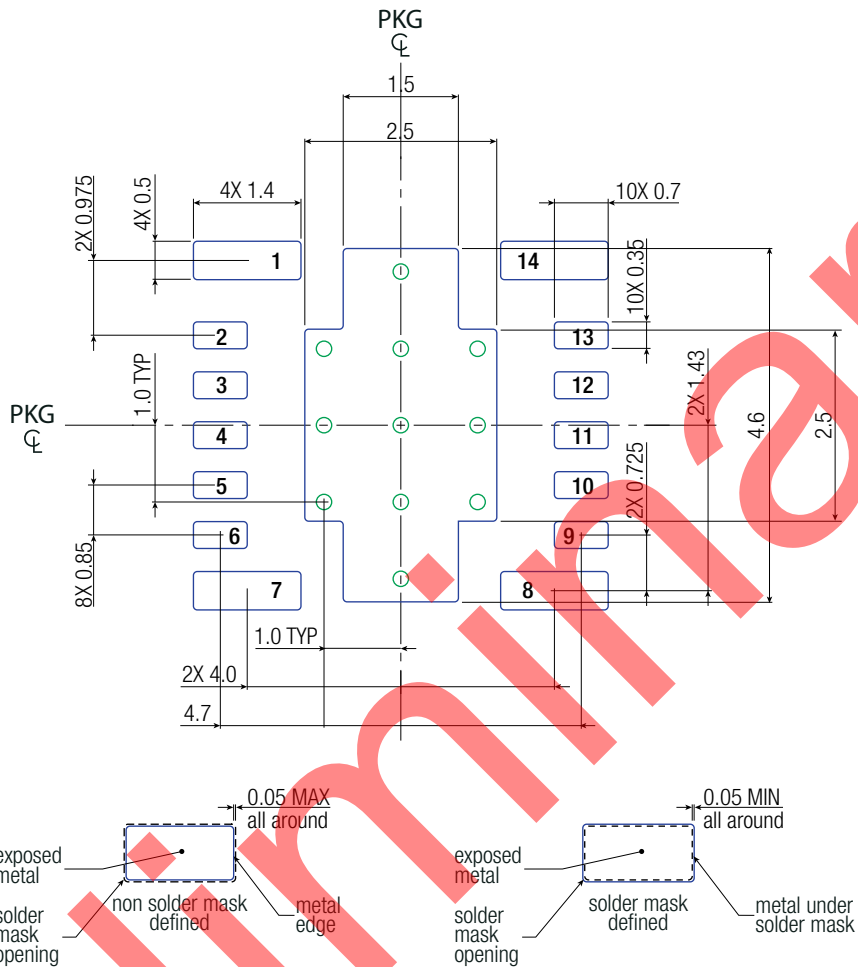

SOLDERING

Wave or Re-flow etc.

Profile Feature	PB-Free Assembly
Preheat	
minimum Temperature (TS_min)	155°C
maximum Temperature (TS_max)	240°C
Time (tS)	100s-300s
Liquids	
Temperature (TL)	217°C
Time (tL)	30-60s
Peak Temperature (TP)	240°C
Time remaining around Peak Temperature	10s
max Ramp Down Rate (from TS_max to TP)	5°C/s
max Ramp Up Rate	3°C/s
max time from 25°C to Peak Temperature (TP)	8min

- 1 Pb-Free assembly is recommended according to JEDEC J-STD020.
- 2 Ensure that the peak re-flow temperature does not exceed 240°C as per JEDEC J-STD020
- 3 The re-flow time period during peak temperature of 240°C should not exceed 30 seconds.
- 4 Re-flow time above liquids (217°C) should not exceed 150 seconds.
- 5 For solder paste use a standard SAC Alloy such as SAC 305, type 3 or higher.
- 6 Other soldering methods (e.g. vapor phase) are not verified and have to be validated by the customer on his own risk.

Solder Profile

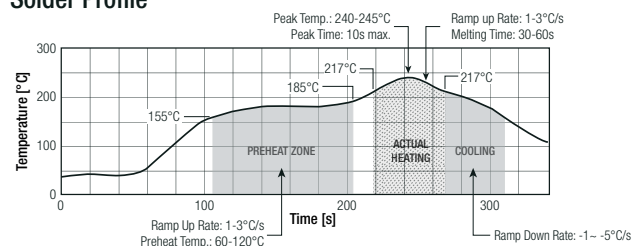

Specifications

PCB LAYOUT SUGGESTION

Layout Considerations:

1. Large copper for power planes (+V_{IN}, V_{OUT}, and -V_{IN}) for enhanced thermal performance.
2. Input and output capacitors should be placed as closely to the pins as possible.
3. Connect GND to -V_{IN}
4. Place R_{FB1} and R_{FB2} as close as possible to the FB pin.
5. Use multiple vias to connect the power planes to internal layers.

Top View

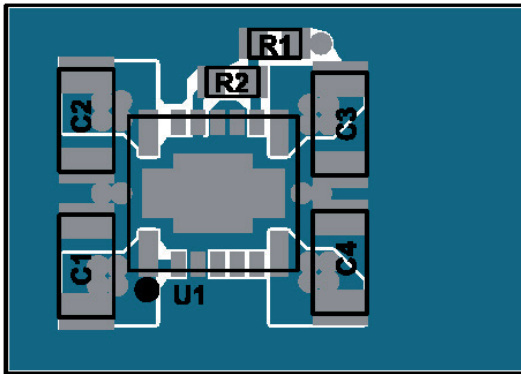

Bottom View

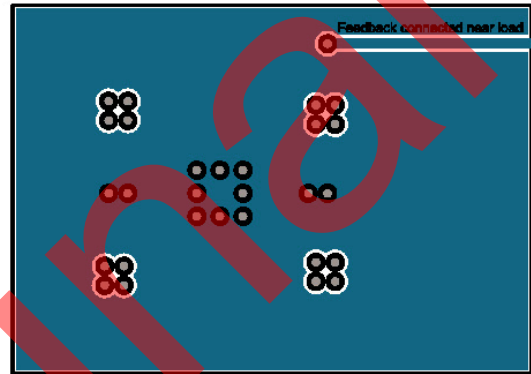

BLOCK DIAGRAM

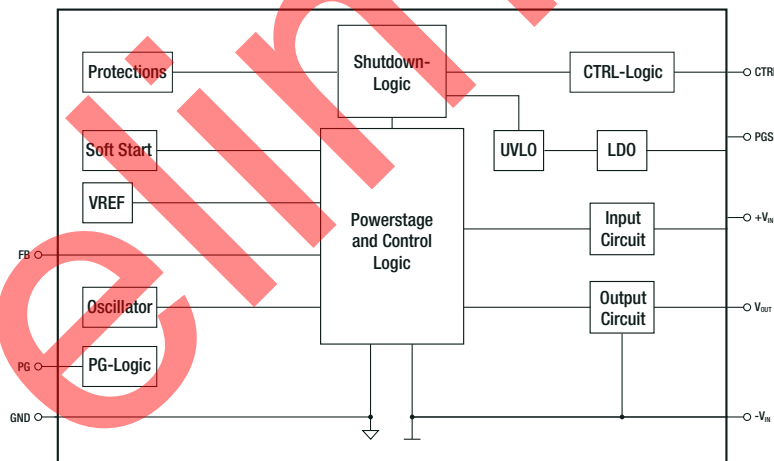

PACKAGING INFORMATION

Parameter	Type	Value
Packaging Dimension (LxWxH)	reel (diameter + width)	Ø330.0 + 16.4mm height
	tape and reel (carton)	336.0 x 336.0 x 48.0mm
	moisture barrier bag ("-CT")	100.0 x 100.0 x 30.0mm
Packaging Quantity	tape and reel ("-R")	500pcs
	moisture barrier bag ("-CT")	10pcs
Tape Width		16.4mm
Storage Temperature Range		-40°C to +150°C
Storage Humidity	non-condensing	95% RH max.

The product information and specifications may be subject to changes even without prior written notice. The product has been designed for various applications; its suitability lies in the responsibility of each customer. The products are not authorized for use in safety-critical applications without RECOM's explicit written consent. A safety-critical application is an application where a failure may reasonably be expected to endanger or cause loss of life, inflict bodily harm or damage property. The applicant shall indemnify and hold harmless RECOM, its affiliated companies and its representatives against any damage claims in connection with the unauthorized use of RECOM products in such safety-critical applications.